

Dolby® E encoder

C8611

features

- Dolby® E compliant Encoder
- 8 channels (up to eight programs)
- Audio input up to 24Bit, 48kHz
- 16 / 20Bit audio data format
- RS485 Metadata input
- Unique Metadata extractor to read Metadata inserted into PCM audio User Bits
- Metadata from C8000 internal audio bus, external RS485 input or presets
- Eight Metadata presets
- Dolby® Metadata display and editing
- Encoded output stream available on C8000 internal audio bus
- Encoded output stream available on unbalanced AES output
- Remote control (web interface) via C8702 frame controller



block diagram

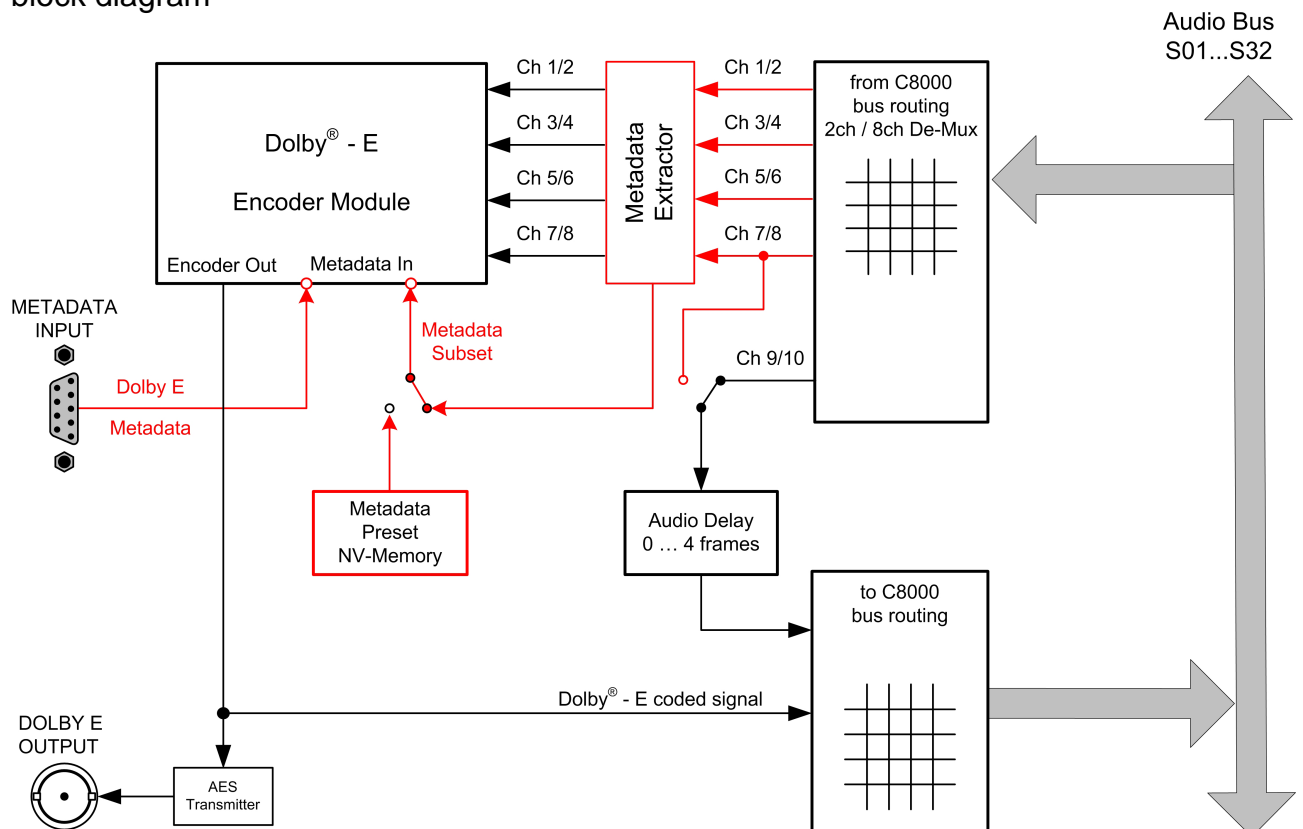

technical specifications

External output:

connector BNC  
impedance 75Ω  
signal level 1V<sub>pp</sub>  
standard AES 3, SMPTE 276M unbalanced  
data format 16, 20bit  
sample rate 48kHz

Output audio formats:

Dolby® E 16, 20bit streams, 48kHz Sample Rate

Latency:

1 video frame

Metadata input:

format Standard Dolby® Metadata stream (RS485)  
baud rate 115,2kbps  
connector Sub-D, 9-pin, female  
pin assignment

connector :	Metadata INPUT
female	9-pin D-Sub
1	GND
2	
3	Rx (+)
4	GND
5	
6	GND
7	
8	Rx (-)
9	GND

Backplane connector: ref. to DIN 41612, 64pin, a+b, male

Power supply: +5V DC

Consumption: approx. 600mA

Dimensions: 3RU, 4HP, 160mmd deep (Euro Format)

Ambient: 10°C to 40°C

Humidity: 90%, non condensing

installation

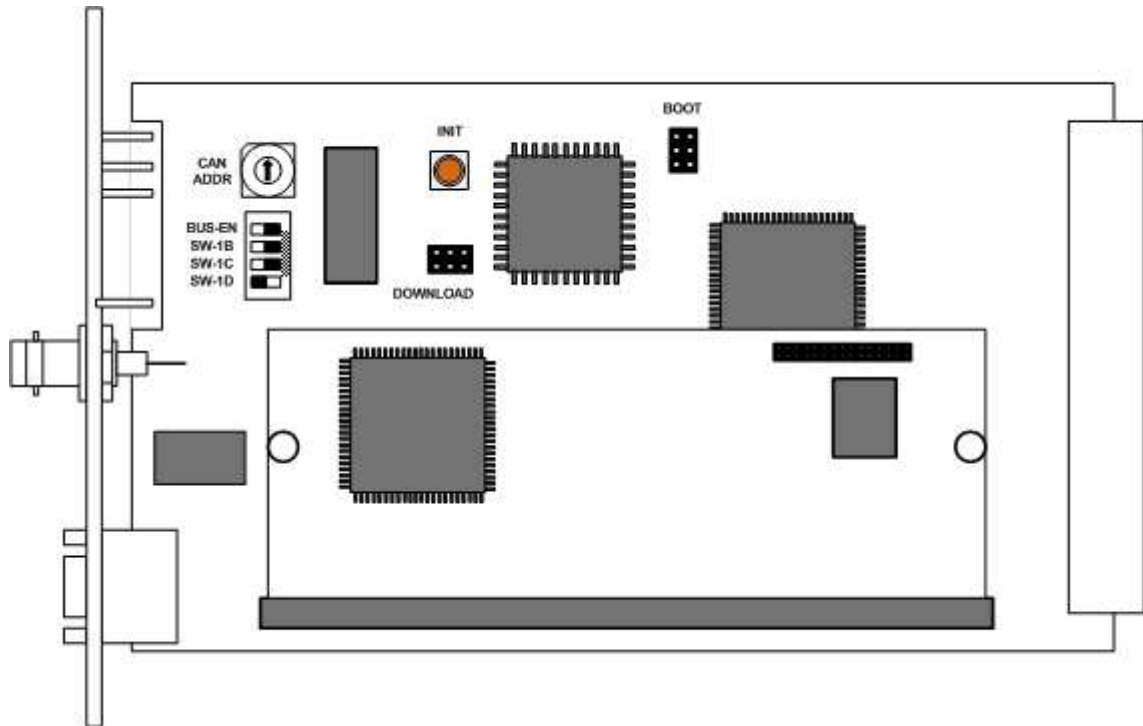

Set the **CAN ADDR** rotary encoder to an address, which is not in use by another module of a C8000 frame (for details regarding CAN addressing, see C8000 system manual).

- BUS-EN** = **OFF** will disable the bus driver circuits on power up
- SW-1B** = **ON** enables the CAN “+16” address schema to handle up to 32 modules
- SW-1C** = not used
- SW-1D** = not used

**Important Note!** If the module has an unknown bus configuration, you must set **BUS-EN=OFF**, before inserting the module into a C8000 frame. Otherwise you risk disturbing other channels of the frame.

Pressing the **INIT** button during power up will initialize the module parameters to factory default values.

status LEDs

- |                  |   |
|------------------|---|
| <b>STATUS</b>    | <b>green</b> = OK   |
|                  | <b>red</b> = bad  |
|                  | <b>flashing</b>   |
|                  | <b>green</b> = under GUI control  |
| <b>VIDEO-REF</b> | <b>green</b> = frame rate matches the one selected for Dolby E encoding   |
|                  | <b>Off</b> = no Frame Reference available or frame rate of the reference does not match the one selected for Dolby E encoding |
| <b>DOLBY E</b>   | <b>blue</b> = the encoder delivers a proper Dolby E signal  |
|                  | <b>Off</b> = Dolby E encoding error (see VIDEO-REF)   |

web browser based configuration

**Set up of all configurations, parameters and functions via a web browser.  
See also C8702 Frame Controller manual.**

## OVERVIEW

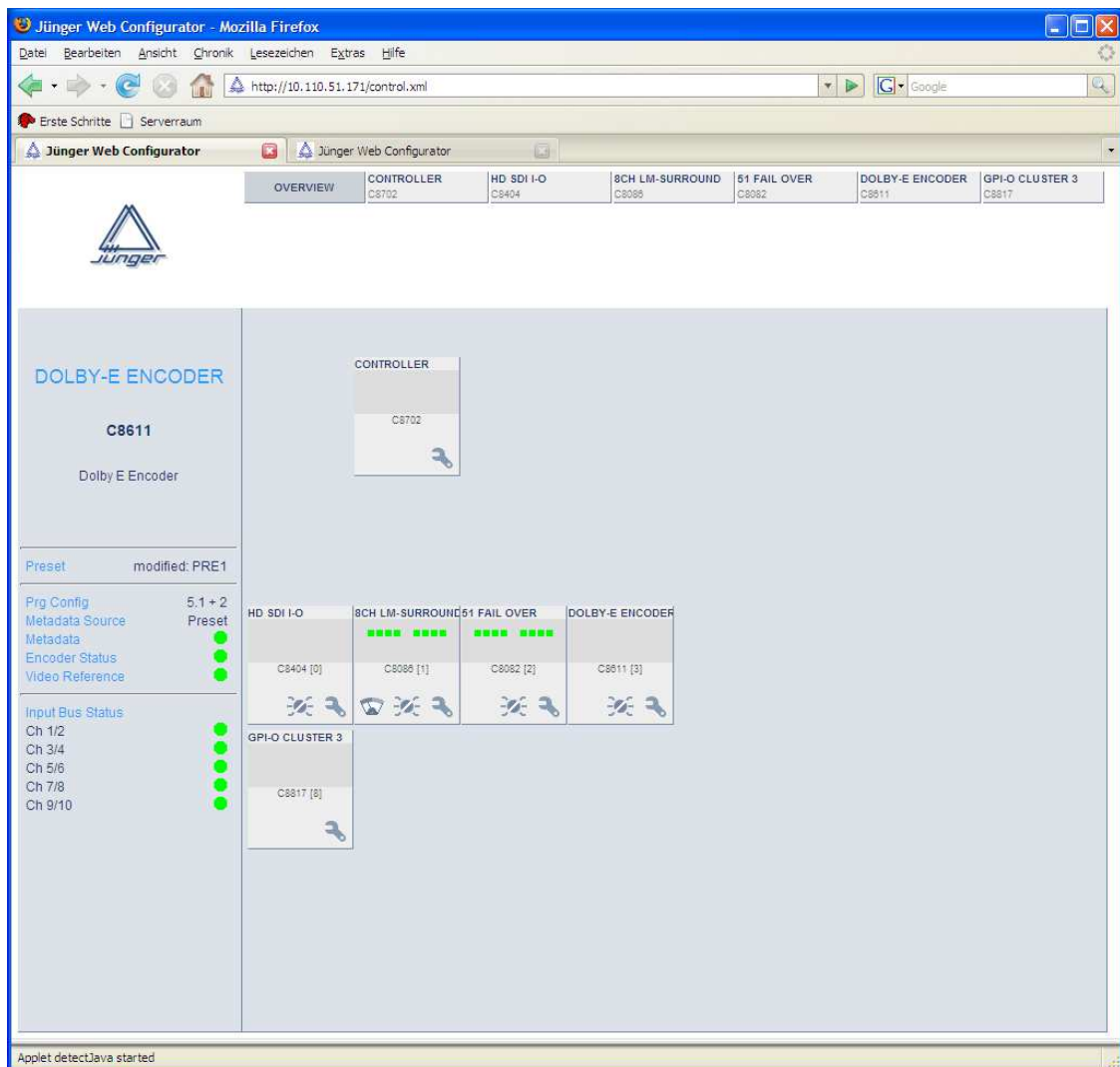

The above example shows a **C8611** (Name: "DOLBY E ENCODER") in a typical processing chain. Clicking on the **spanner tool** within the module graphics of the **C8611** will open the pages of that module.

If you click on the **switch tool** you will get the page for changing Presets only.

## PRESETS



### Metadata

the module provides 16 Metadata presets which may be used when the Metadata source is set to Preset. The settings found on the **DOLBY E** and **PROG. METADATA** pages are stored in Presets. If the Metadata Source is set to "Bus". Each parameter may be overwritten independently on the respective pages. In this case the preset will keep these values.

### Input Bus Routing

the modules provides 8 preset which may be used to set up the routing of the input busses (e.g. to select different audio inputs from the system).

### Load Preset

will load one of the 8 available Presets from the modules **NV memory**.

### Save as Preset

here you can select a Preset Number (memory location) and assign that preset a 16 character name.

## Dolby® E encoder

# C8611

### Preset Clipboard

you can copy the data of the active parameters of the two sets of Presets to a **clip board** and paste such data into the Preset memory of another module within one frame.

### Backup Presets

store all presets of one **C8611** into a file.

### Restore Presets

restore all presets of a **C8611** from a file.

## DEVICE

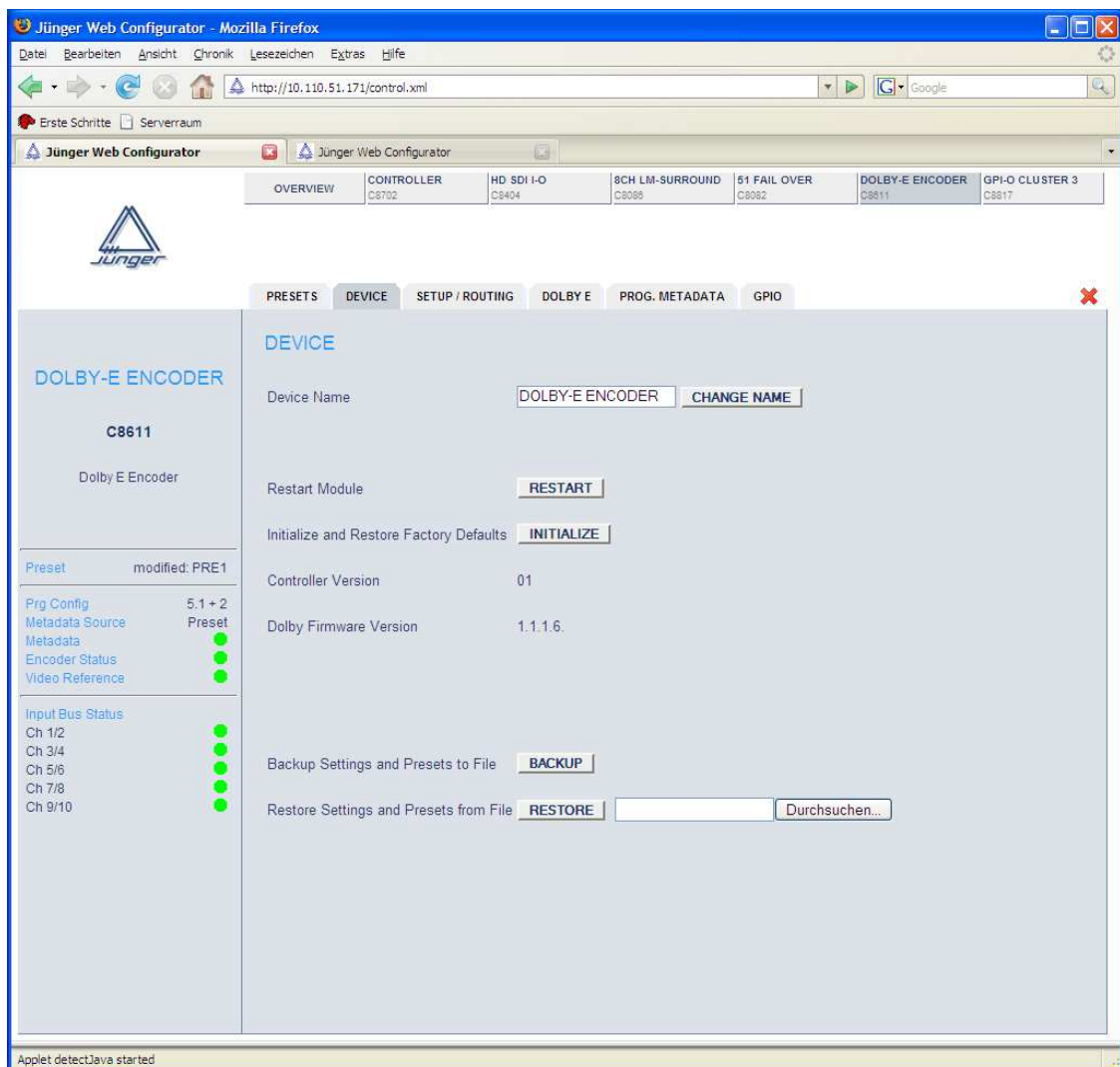

### Device Name

You can assign a **16 digit name** to the module.

### Restart Module

Pressing **<RESTART>** will warm start the module.

### Initialize

Pressing **<INITIALIZE>** will initialize the module to factory default.

### Controller Version

Display of the firmware version of the module controller.

### Dolby Firmware Version

Version of the Dolby piggyback module.

Dolby® E encoder

C8611

**BACKUP**

Pressing **<BACKUP>** will move all settings including the Presets to the PC, so you can store the backup data to a file.

**RESTORE**

Pressing **<RESTORE>** after loading a backup file will move all settings including the Presets back to the module.

**SETUP / ROUTING :**

setup of the module and the Bus routing

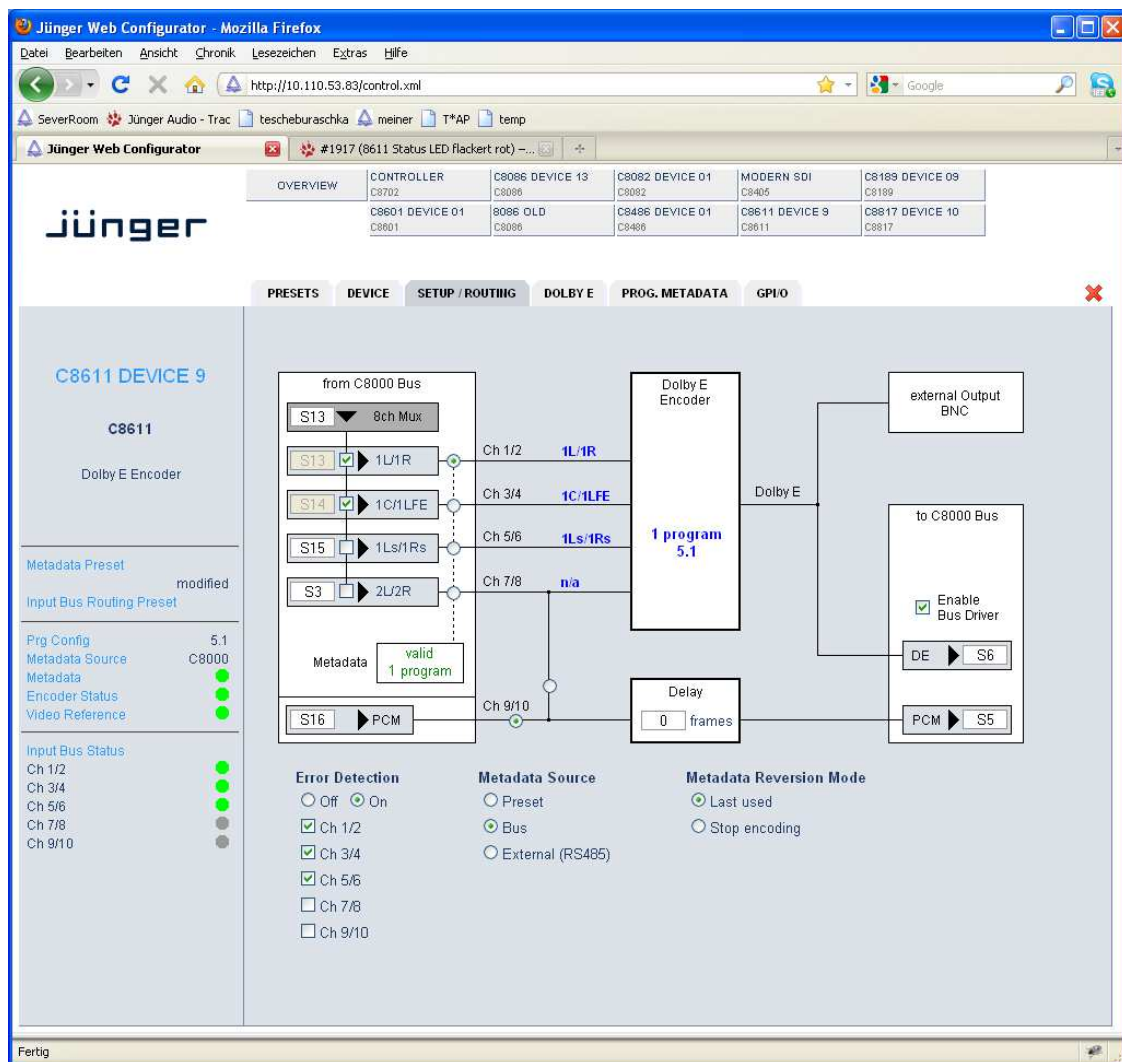

**From C8000 Bus**

The audio busses from the C8k frame must be assigned to the encoder for the respective signals. The labels at the encoder input show which signals the encoder expects due to its configuration determined by **Program Config** (see DOLBY E page). If some of the 8 input signals are multiplexed in 8ch mode, you must check the respective channel check boxes (see example above). This is the so called **MixMux** mode where the module may be fed from a combination of 2Ch and 8Ch signals.

**8ch Mux**

here one must select the bus that is fed in 8 channel Mux mode from an upstream module. The check boxes below determine which channel pair will be taken from the 8 channel Mux.



Dolby® E encoder

C8611

<b>Metadata</b>	The Metadata maybe inserted in the USER bits of the PCM signal(s) on the C8k audio busses. Here you can select from which bus it should be read.
<b>PCM</b>	An independent digital stereo (or 2Ch) audio signal (PCM or encoded) may be taken from the c8k bus to compensate for the Dolby E encoding delay.
<b>Delay</b>	The module provides a 2ch delay (up to 4 frames) to compensate for the Dolby E encoding delay.
<b>To C8000 System Bus</b>	The encoder output may be assigned to the C8k busses. It is fed to the external BNC output as well.
<b>Enable Bus Driver</b>	You may turn off (tri state mode) all bus drivers for installation to prevent conflicts with modules already in service.
<b>External Output BNC</b>	The Dolby E encoded bit stream is sent out via an unbalanced AES3 output in parallel to the C8k audio bus
<b>Metadata Source</b>	<b>Preset :</b> The parameters to setup the Dolby E encoder and the program Metadata are defined manually. You may also load a Preset edit these parameters and store them as a Preset again. <b>Bus :</b> The Metadata for the Dolby E encoder are extracted from the USER bits in Metadata Subset format of one of the incoming PCM signals <b>external (RS485) :</b> The Metadata for the Dolby E encoder are received by the 9-pin Sub D connector at the front side of the module in Dolby E format.
<b>Error Detection</b>	The serial audio data from the frame bus can be monitored for proper positioning of an <b>Error-Flag</b> . A bad <b>Error-Flag</b> is an indication that there is disturbance upstream (input signal, input module, DSP module). The <b>Error Detection</b> can be turned <b>Off</b> and <b>On</b> for each input from the bus. You will see the status on the left hand side: " <b>Input Bus Status</b> ". A <b>grey</b> "LED" shows that the detection is disabled. While <b>green</b> is OK, <b>red</b> indicates an error condition. The bus status may be presented to external monitoring systems via <b>SNMP</b> . The frame controller summarizes such status information and generates <b>SNMP traps</b> for the frame as an entity or may activate GPOs (if GPI/O module(s) are installed). The <b>SNMP manager</b> may afterwards poll the " <b>modulesStatus</b> " for more detailed status information per input (see SNMP documentation for details).
<b>Metadata Reversion Mode</b>	<b>Last used :</b> If a Metadata error is detected from the source, the encoding process will continue with "last used" parameters <b>Stop encoding :</b> The encoder will stop encoding in case of a Metadata error from the input



## Dolby® Metadata

The Dolby® Laboratories, Inc. have introduced the “**data about the audio data**“, the Dolby® Metadata which travel along with the multi channel bit stream from acquisition (point of audio recording) to delivery (Dolby Digital decoder at home either as part of the TV Set Top Box or the home theater system). Dolby® Metadata in the end of the day may control the home equipment in a way that the sound impression is as close as possible to what the producers intention was when mixing a movie sound track.

There is not enough room for explanation of the Dolby Metadata system in a product manual like this. We recommend to those who are not familiar with this quite complex matter, to study the many publications from Dolby Inc. probably found here:

<http://www.dolby.com/technicallibrary.aspx?id=306>

You can browse the Technical Library and **<Search>** for “**Dolby E**“. Here you will find the “**Dolby® Metadata Guide**“.

**DOLBY E :** setup of the **Dolby E** related Metadata

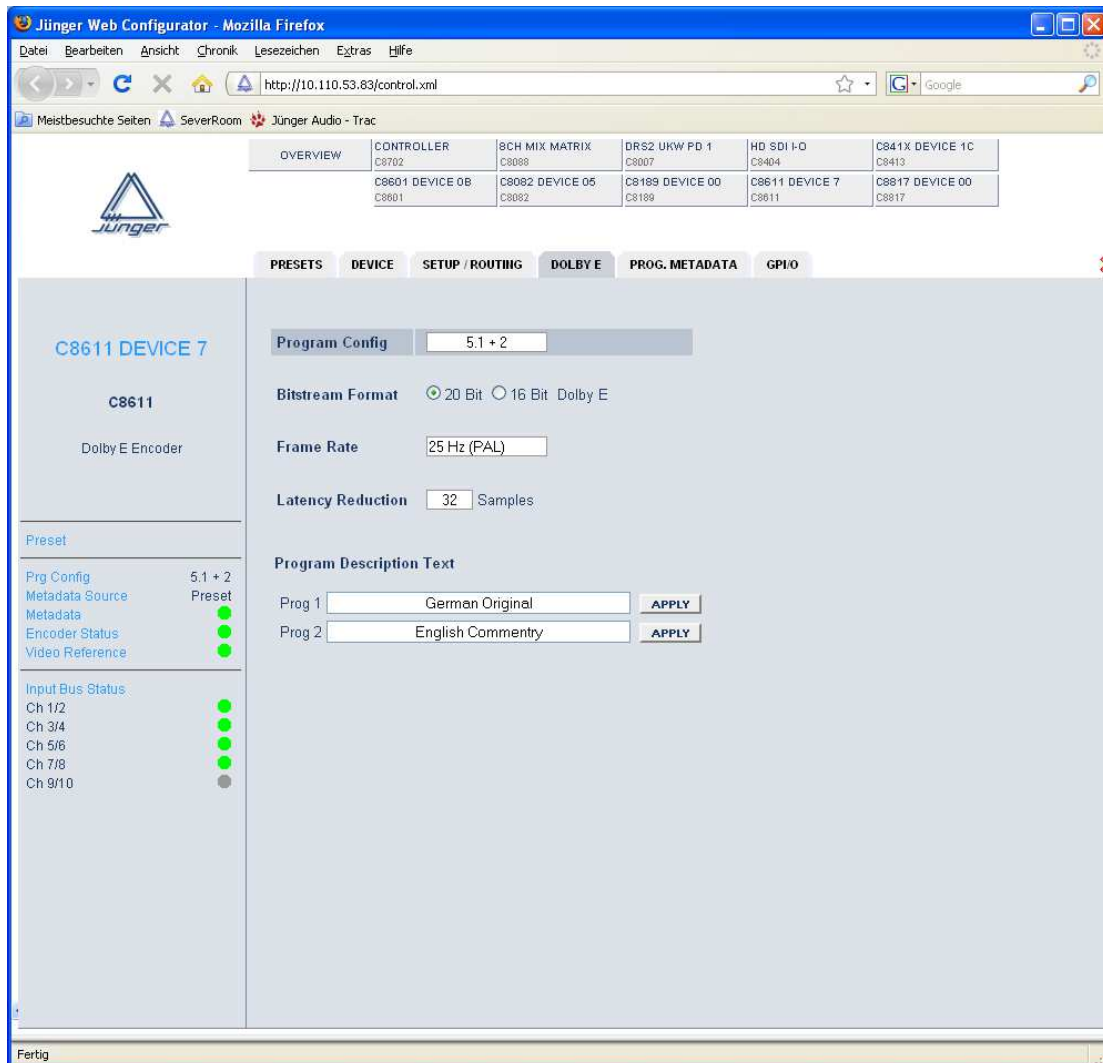

The **Dolby E** parameters contain the information of the **Dolby E** stream. The table below shows the parameters and their possible values :

Parameter	Range
Program Configuration	5.1+2, 5.1 +2x1, 4+4, 4+2x2, 4+2+2x1, 4+4x1 4x2, 3x2+2x1, 2x2+4x1, 2+6x1, 8x1 5.1, 4+2, 4+2x1, 3x2, 2x2+2x1, 2+4x1, 6x1 4, 2+2, 2+2x1, 4x1 7.1, 7.1SCRN
Bitstream Format	Dolby E 16Bit, Dolby E 20Bit
Frame Rate	None, 23,98Hz, 24Hz, 25Hz (PAL) 29,97Hz (NTSC), 30Hz, 50Hz, 59,94Hz, 60Hz
Latency Reduction (Dolby E alignment)	0 ... 32 Samples (moves the beginning of the Dolby E frame towards the start of the video frame)
Program Description Text	32-character text coded program

**PROG. METADATA :**

Setup of **Dolby Digital Metadata**  
example below shows **2 programs** (5.1 & stereo) :

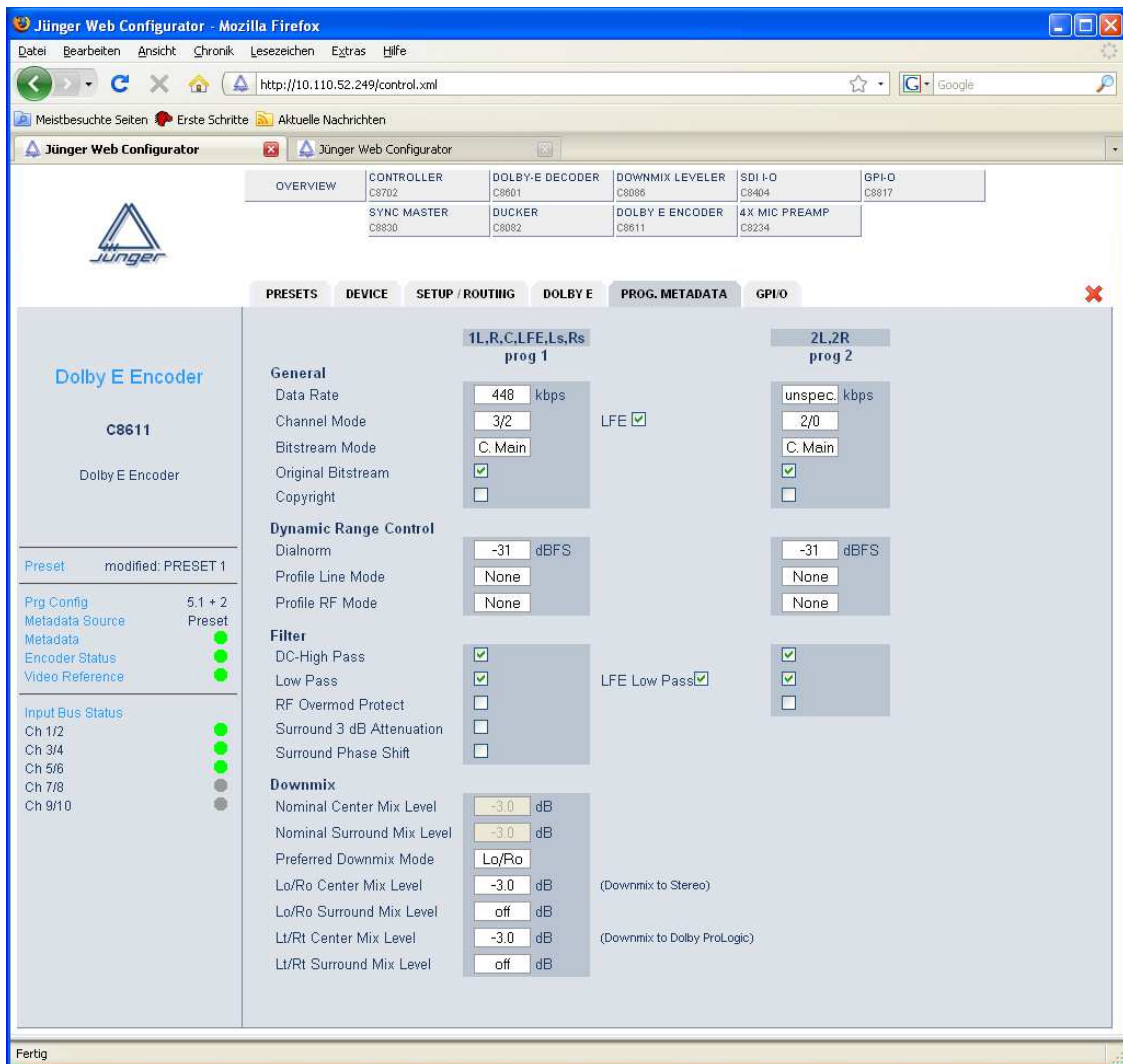

The **PROG.METADATA** are used to set up the **Dolby D encoder** and control the **Dolby D decoder** at home.

A lot of these Metadata are applicable only for surround programs.

The table on the next page is an example for 2 programs. The possible Data Rate depends on the Channel Mode (some channel modes require a minimum Data Rate).

Parameter	Range - Program 1	Range - Program 2
<b>General</b>		
Data Rate (kbps)	32, 40, 48, 56, 64, 80, 96, 112, 128, 160, 192, 224, 256, 320, 384, 448, 512, 576, 640, unspecified.	32, 40, 48, 56, 64, 80, 96, 112, 128, 160, 192, 224, 256, 320, 384, 448, 512, 576, 640, unspecified.
Channel Mode	1+1, 1/0, 2/0, 3/0, 2/1, 3/1, 2/2, 3/2	1+1, 1/0, 2/0
LFE	On, Off	N.A.
Bit Stream Mode	C. Main, Mus Eff Vis. Imp, H. Imp Dialogue, Comment Emerg., Karaoke	C. Main, Mus Eff Vis. Imp, H. Imp Dialogue, Comment Emerg., Karaoke
Original Bit Stream	On, Off	On, Off
Copyright	On, Off	On, Off
<b>Dynamic Range Control</b>		
Dialog Normalization	-1dBFS ... -31dBFS	-1dBFS ... -31dBFS
Profile Line Mode	None, Film St Film Lt, Mus St Mus Lt, Speech	None, Film St Film Lt, Mus St Mus Lt, Speech
Profile RF Mode	None, Film St Film Lt, Mus St Mus Lt, Speech	None, Film St Film Lt, Mus St Mus Lt, Speech
<b>Filter</b>		
DC-Highpass	On, Off	On, Off
Low Pass	On, Off	On, Off
LFE Low Pass	On, Off	N.A.
RF Overmod. Protection	On, Off	On, Off
Surround 3dB Attenuation	On, Off	N.A.
Surround Phase Shift	On, Off	N.A.
<b>Downmix</b>		
Nominal Center Mix Level	-3dB, -4,5dB, -6dB	N.A.
Nominal Surround Mix Level	-3dB, -6dB, OFF	N.A.
Preferred Downmix Mode	Not indicated Lt/Rt, Lo/Ro	N.A.
Lo/Ro Center Mix Level	OFF, -6dB, -4,5dB -3dB, -1,5dB, 0dB 1,5dB, 3dB	N.A.
Lo/Ro Surround Mix Level	OFF, -6dB, -4,5dB -3dB, -1,5dB, 0dB 1,5dB, 3dB	N.A.
Lt/Rt Center Mix Level	OFF, -6dB, -4,5dB -3dB, -1,5dB, 0dB 1,5dB, 3dB	N.A.
Lt/Rt Surround Mix Level	OFF, -6dB, -4,5dB -3dB, -1,5dB, 0dB 1,5dB, 3dB	N.A.

GPI/O

setup of the GPI/Os

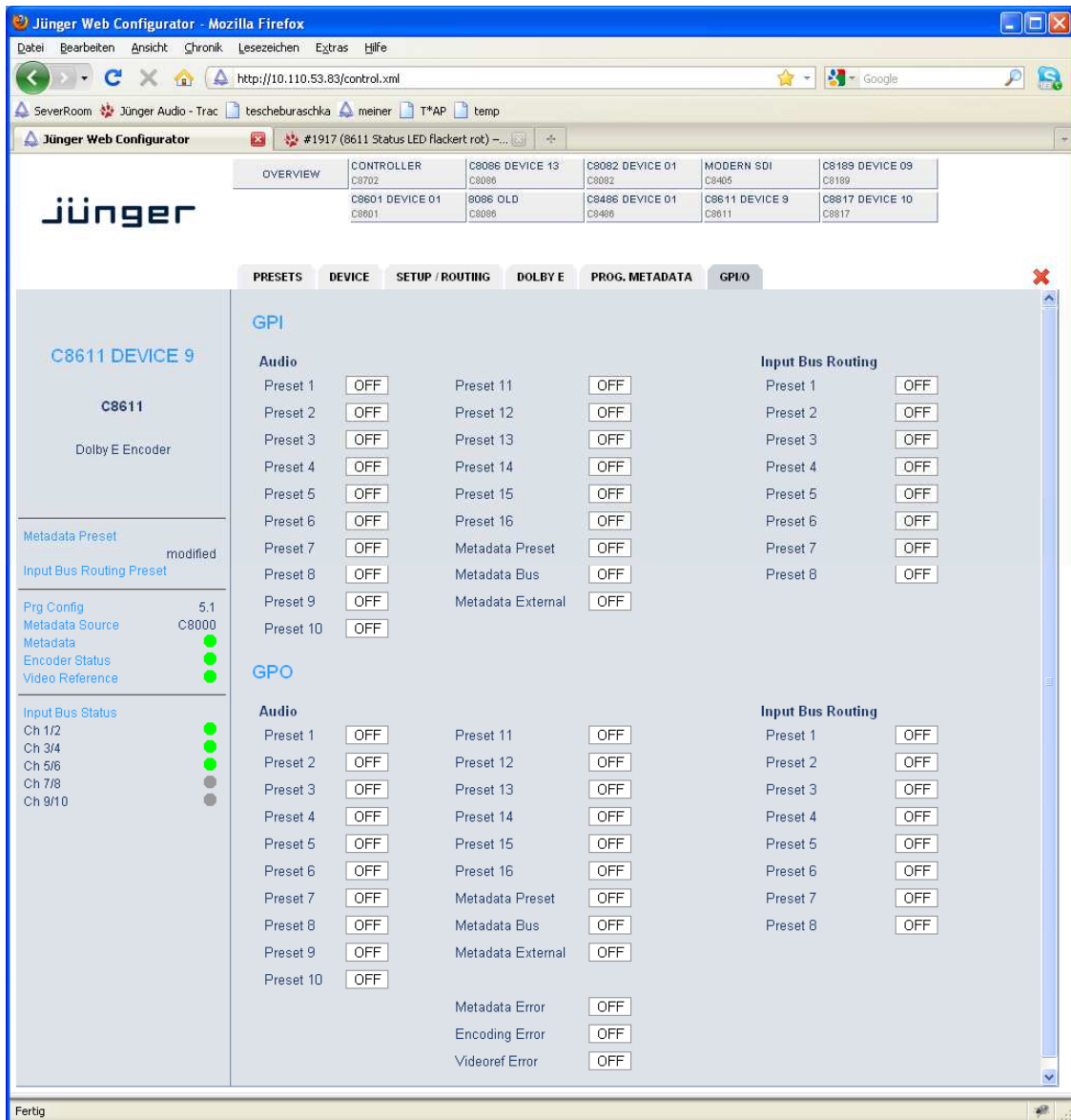

You can assign **GPI numbers** to activate one of the various **Presets**.

If a **GPI** is detected by a **GPI/O** module of the C8k system, it puts an associated number on the **CAN** bus. Each module in a frame permanently listens for such numbers and will perform the pre-programmed action if it reads that number.

You can assign **GPO** numbers which will indicate the respective action.

E.g. if an Encoding Error occurs the C8611 puts the associated **GPO number** on the **CAN bus**. The GPI/O module permanently listens for such numbers. If it reads such number it will engage the respective **GPO** (see C8817 manual for details).